



Input characteristics

Control voltage		3.5...32VDC
Operating voltage limits		
	Operating voltage pick-up	V 3.5
	Operating voltage drop-out	V 2
Input current at min...max voltage	mA	10...13
Input reverse voltage	V	32

Operating times

Switching-on	Half cycle max
Switching-off	Half cycle max

Output characteristics

Static output type		SCR (silicon controlled rectifier)
Switching mode		Zero crossing
Rated operating voltage	VAC	24...510
Blocking voltage	V	1200
Operational frequency (min...max)	Hz	45...65
Rated operating current AC-51 (resistive load) at 40°C	A	40
Rated operating current AC-51 (resistive load) at 55°C	A	35
Thermal resistance between junction to case	K/W	0.55
Heatsink for use at 40°C and 55°C at rated current AC-51	K/W	≤0.9
Rated operating current AC-53 (motor load) at 40°C	A	7
Operational current min	A	0.05
Non repetitive surge peak on state current t=10ms	A	500
Off state leakage current	mA	1
On state output voltage drop	V	1.5
Critical rate of rise of off-state voltage dv/dt	V/μs	500
Input - Output isolation	V	4000
Input - Output to metal base	V	4000
Output protection type		VDR
I2t	A2s	1250

Terminal characteristics

Control terminals	Type	Screw M4
Terminals tool		PZ2
Tightening torque control terminals	Nm	1.2...2
	Ibin	10.6...17.7
Conductor section connectable (control terminals) with 1 or 2 wires min...max		
	AWG stranded	n° 18...14
	Flexible w/o lug	mm2 0.75...2.5
	Flexible c/w insulated spade lug	mm2 0.75...2.5
Load terminals	Type	Screw M5
Load terminals tool		PZ2
Tightening torque load terminals		

	Nm	2...3
	lbin	20.4
Conductor section connectable (load terminals) with 1 or 2 wires min...max		
	AWG stranded	n° 16...10
	Flexible w/o lug	mm2 1.5...6
	Flexible c/w insulated spade lug	mm2 1.5...6
Operating position		
	allowable	Any
Fixing		
		Screw
Ambient conditions		
Temperature		
Operating temperature		
	min	°C -40
	max	°C +90
Storage temperature		
	min	°C -40
	max	°C +100

Dimensions

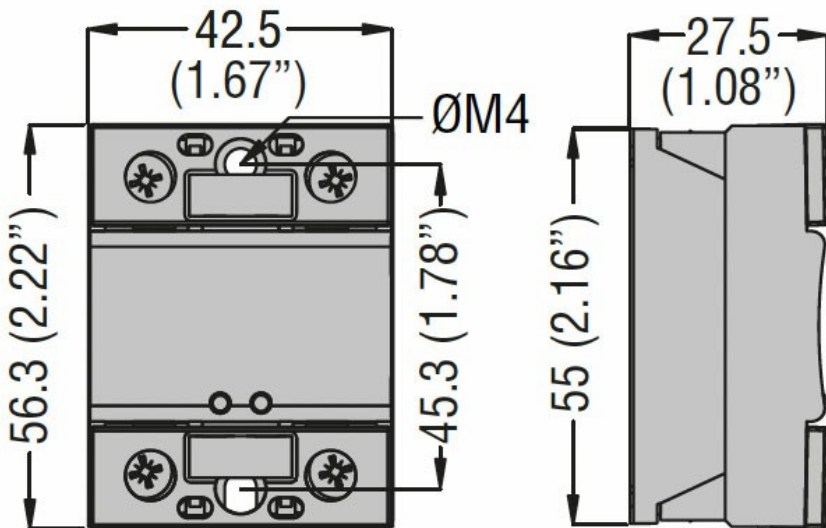

Wiring diagrams

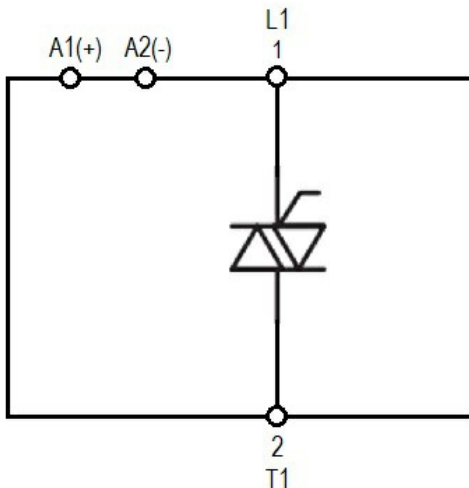

Certifications and compliance

Certifications

IEC/EN/BS 60335-1
IEC/EN/BS 60947-4-2
IEC/EN/BS 60947-4-3
IEC/EN/BS 62314

Compliance

CSA
cURus
VDE

ETIM classification

EC000066 - Power contactor, AC switching