



Input characteristics

Control voltage		18...280VAC/DC
Operating voltage limits		
	Operating voltage pick-up	V 18
	Operating voltage drop-out	V 8
Input current at min...max voltage	mA	4.5...6

Operating times

Switching-on	Half cycle max
Switching-off	Half cycle max

Output characteristics

Static output type		SCR (silicon controlled rectifier)
Switching mode		Zero crossing
Rated operating voltage	VAC	24...600
Blocking voltage	V	1200
Operational frequency (min...max)	Hz	45...65
Rated operating current AC-51 (resistive load) at 40°C	A	40
Rated operating current AC-51 (resistive load) at 55°C	A	35
Thermal resistance between junction to case	K/W	0.55
Heatsink for use at 40°C and 55°C at rated current AC-51	K/W	≤0.9
Operational current min	A	0.05
Non repetitive surge peak on state current t=10ms	A	500
Off state leakage current	mA	1
On state output voltage drop	V	1.5
Critical rate of rise of off-state voltage dv/dt	V/μs	500
Input - Output isolation	V	4000
Input - Output to metal base	V	4000
Output protection type		TVS
I2t	A2s	1250

Terminal characteristics

Control terminals	Type	Screw M4
Terminals tool		PZ2
Tightening torque control terminals	Nm	1.2...2
	Ibin	10.6...17.7
Conductor section connectable (control terminals) with 1 or 2 wires min...max		
	AWG stranded	n° 18...14
	Flexible w/o lug	mm2 0.75...2.5
	Flexible c/w insulated spade lug	mm2 0.75...2.5
Load terminals	Type	Screw M5
Load terminals tool		PZ2
Tightening torque load terminals	Nm	2...3
	Ibin	20.4

Conductor section connectable (load terminals) with 1 or 2 wires min...max

AWG stranded	n°	16...10
Flexible w/o lug	mm2	1.5...6
Flexible c/w insulated spade lug	mm2	1.5...6

Operating position

allowable Any

Fixing

Screw

Ambient conditions

Temperature

Operating temperature

min	°C	-40
max	°C	+90

Storage temperature

min	°C	-40
max	°C	+100

Dimensions

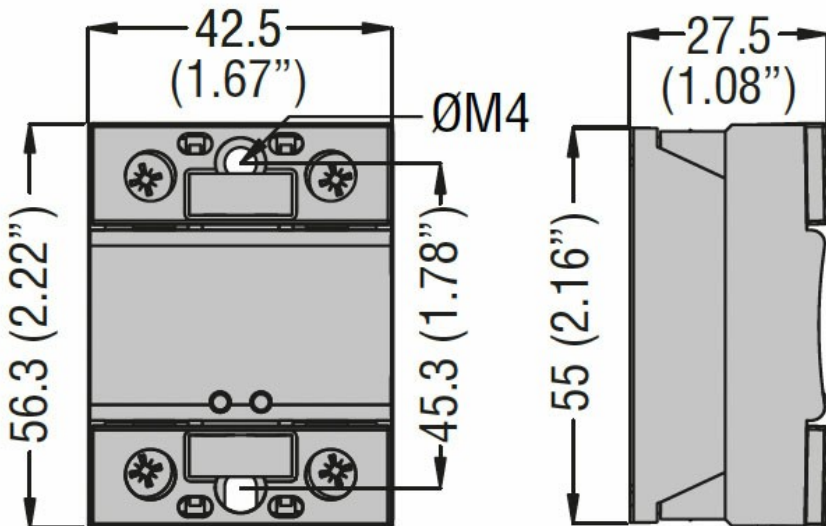

Wiring diagrams

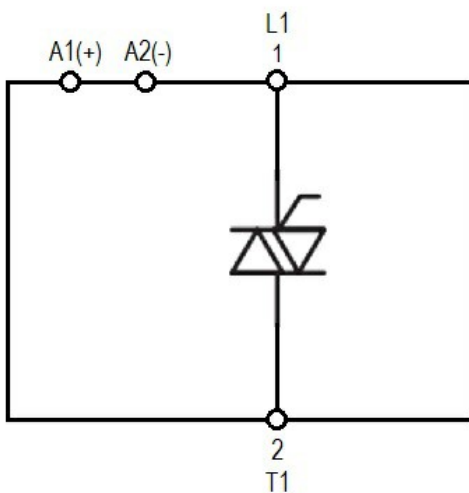

Certifications and compliance

Certifications

IEC/EN/BS 60335-1
IEC/EN/BS 60947-4-2

IEC/EN/BS 60947-4-3

IEC/EN/BS 62314

Compliance

cURus

VDE

ETIM classification

EC000066 - Power contactor, AC switching