



Input characteristics

Control voltage			3...32VDC
Operating voltage limits			
	Operating voltage pick-up	V	3
	Operating voltage drop-out	V	2
Input current at min...max voltage		mA	4...12

Operating times

Switching-on			Half cycle max
Switching-off			Half cycle max

Output characteristics

Static output type			SCR (silicon controlled rectifier)
Switching mode			Zero crossing
Rated operating voltage	VAC		12...275
Blocking voltage	V		600
Operational frequency (min...max)	Hz		45...65
Rated operating current AC-51 (resistive load) at 40°C	A		25
Rated operating current AC-51 (resistive load) at 55°C	A		22
Operational current min	A		0.165
Non repetitive surge peak on state current t=10ms	A		520
Off state leakage current	mA		1
On state output voltage drop	V		1.2
Critical rate of rise of off-state voltage dv/dt	V/μs		500
Input - Output isolation	V		5000
Input - Output to metal base	V		5000
Output protection type			VDR
I2t	A2s		1350

Terminal characteristics

Control terminals	Type		Screw
Terminals tool			Blade 3.5mm
Tightening torque control terminals	Nm		0.5Nm
	Ibin		4.5
Conductor section connectable (control terminals) with 1 or 2 wires min...max			
	AWG stranded	n°	28...12
	Flexible w/o lug	mm2	0.75...2.5
	Flexible c/w insulated spade lug	mm2	0.75...2.5
Load terminals	Type		Screw
Load terminals tool			PH2
Tightening torque load terminals	Nm		1.5
	Ibin		13.3
Conductor section connectable (load terminals) with 1 or 2 wires min...max			
	AWG stranded	n°	18...10

Flexible w/o lug	mm ²	1...6
Flexible c/w insulated spade lug	mm ²	1...16

Operating position

allowable

On vertical plane

Fixing

Screw or on
35mm DIN rail

Ambient conditions

Temperature

Operating temperature

min	°C	-40
max	°C	+80

Storage temperature

min	°C	-40
max	°C	+130

Dimensions

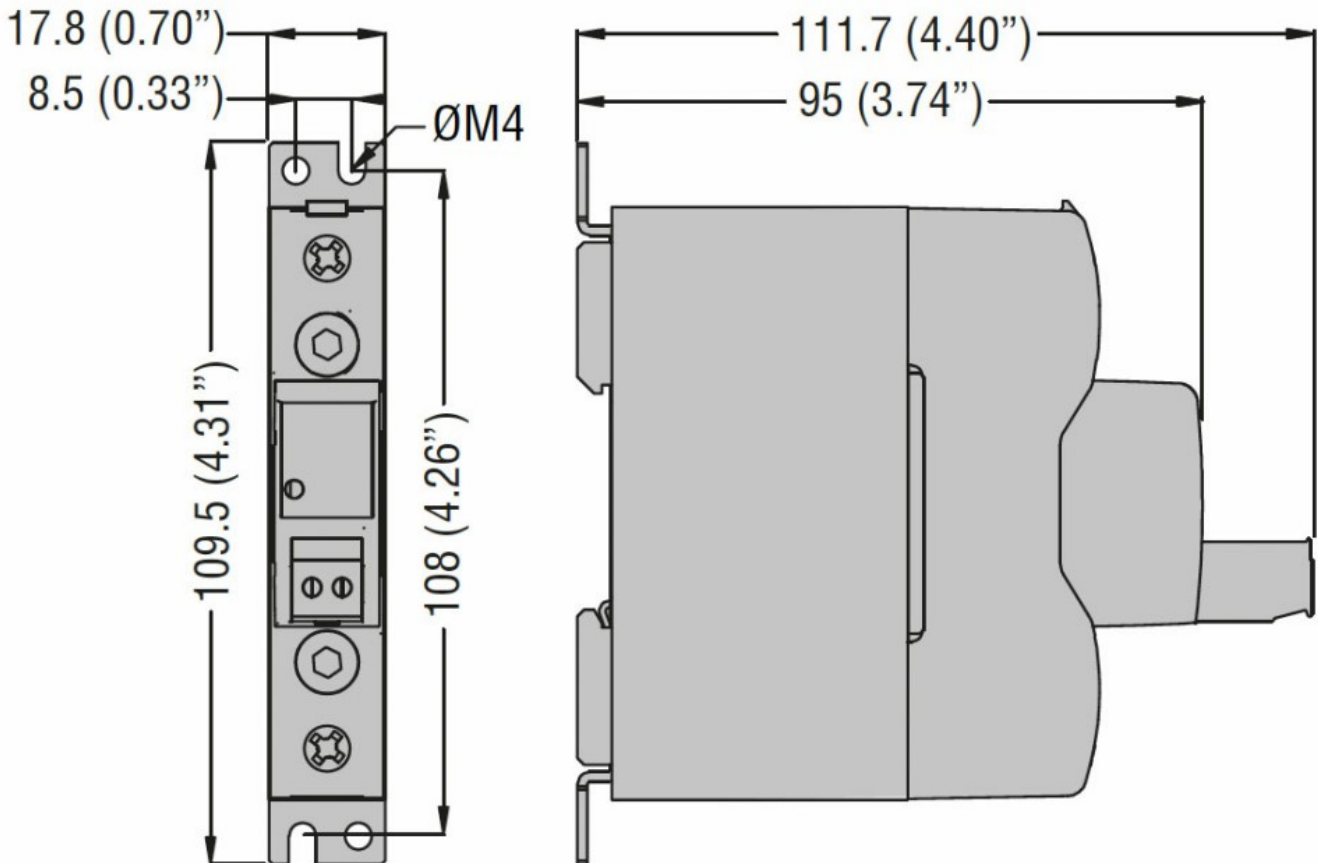

Wiring diagrams

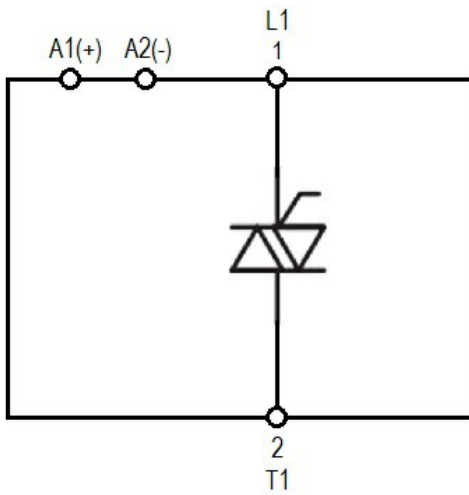

Certifications and compliance

Certifications

IEC/EN/BS 60335-1

IEC/EN/BS 60947-4-2

IEC/EN/BS 60947-4-3

IEC/EN/BS 62314

Compliance

cULus

ETIM classification

EC000066 - Power contactor, AC switching