



Input characteristics			
Control voltage			90...280VAC
Operating voltage limits			
	Operating voltage pick-up	V	45
	Operating voltage drop-out	V	20
Input current at min...max voltage		mA	5...22
Operating times			
Switching-on			Half cycle max
Switching-off			Half cycle max
Output characteristics			
Static output type			SCR (silicon controlled rectifier)
Switching mode			Zero crossing
Rated operating voltage	VAC		48...600
Blocking voltage	V		1200
Operational frequency (min...max)	Hz		45...65
Rated operating current AC-51 (resistive load) at 40°C	A		40
Rated operating current AC-51 (resistive load) at 55°C	A		32
Operational current min	A		0.165
Non repetitive surge peak on state current t=10ms	A		520
Off state leakage current	mA		1
On state output voltage drop	V		1.2
Critical rate of rise of off-state voltage dv/dt	V/μs		1000
Input - Output isolation	V		5000
Input - Output to metal base	V		5000
Output protection type			VDR
I2t	A2s		1350
Terminal characteristics			
Control terminals	Type		Screw
Terminals tool			Blade 3.5mm
Tightening torque control terminals		Nm	0.5Nm
		Ibin	4.5
Conductor section connectable (control terminals) with 1 or 2 wires min...max			
	AWG stranded	n°	28...12
	Flexible w/o lug	mm2	0.75...2.5
	Flexible c/w insulated spade lug	mm2	0.75...2.5
Load terminals	Type		Screw
Load terminals tool			PH2
Tightening torque load terminals		Nm	1.5
		Ibin	13.3
Conductor section connectable (load terminals) with 1 or 2 wires min...max			
	AWG stranded	n°	18...10

Flexible w/o lug	mm ²	1...6
Flexible c/w insulated spade lug	mm ²	1...16

Operating position	allowable	On vertical plane
Fixing		Screw or on 35mm DIN rail

Ambient conditions

Temperature	Operating temperature	min	°C	-40
		max	°C	+80
	Storage temperature	min	°C	-40
		max	°C	+130

Dimensions

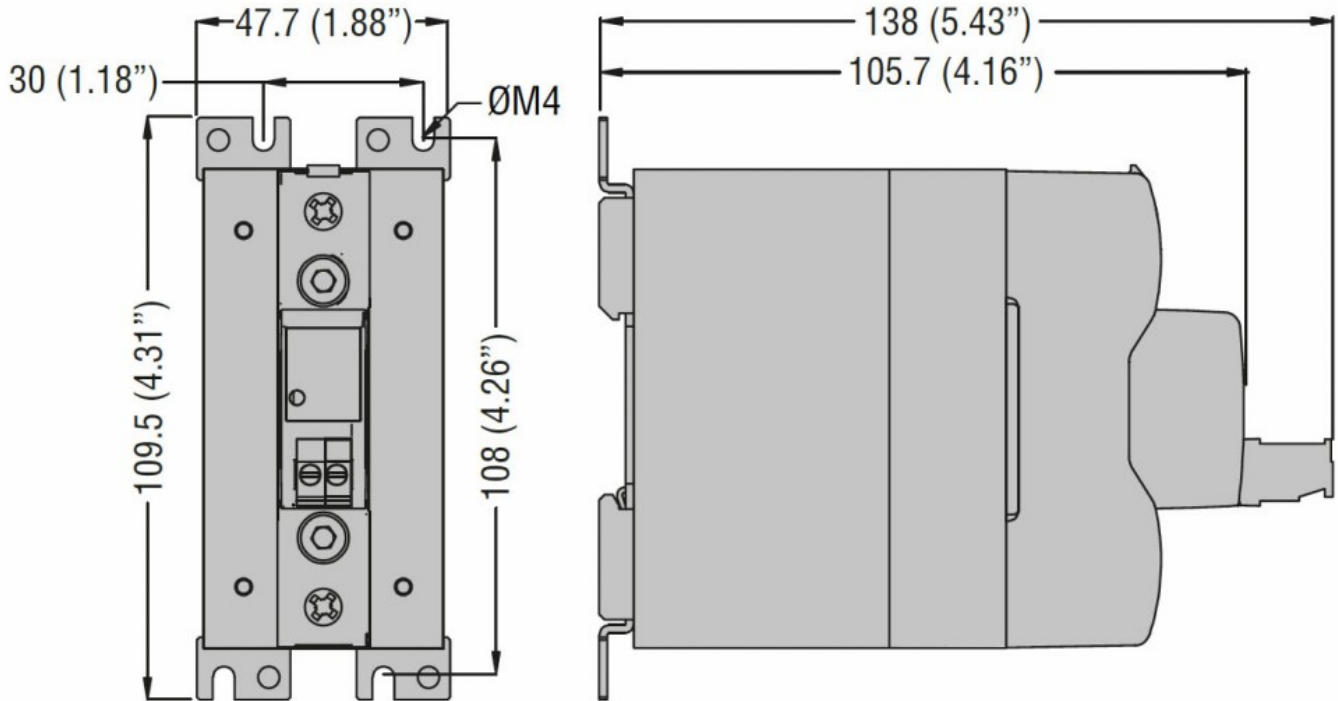

Wiring diagrams

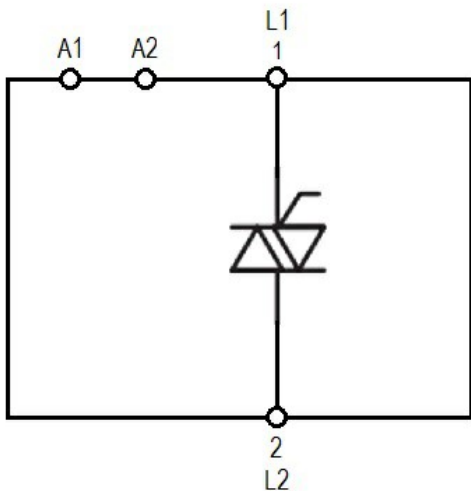

Certifications and compliance

Certifications

IEC/EN/BS 60335-1
IEC/EN/BS 60947-4-2
IEC/EN/BS 60947-4-3
IEC/EN/BS 62314

Compliance

cULus

ETIM classification

EC000066 - Power contactor, AC switching