



Input characteristics

Control voltage		4...32VDC
Operating voltage limits		
	Operating voltage pick-up	V 4
	Operating voltage drop-out	V 2
Input current at min...max voltage	mA	8...12

Operating times

Switching-on	Half cycle max
Switching-off	Half cycle max

Output characteristics

Static output type		SCR (silicon controlled rectifier)
Switching mode		Zero crossing
Rated operating voltage	VAC	48...600
Blocking voltage	V	1200
Operational frequency (min...max)	Hz	45...65
Rated operating current AC-51 (resistive load) at 40°C	A	40
Rated operating current AC-51 (resistive load) at 55°C	A	32
Operational current min	A	0.165
Non repetitive surge peak on state current t=10ms	A	520
Off state leakage current	mA	1
On state output voltage drop	V	1.2
Critical rate of rise of off-state voltage dv/dt	V/μs	1000
Input - Output isolation	V	5000
Input - Output to metal base	V	5000
Output protection type		VDR
I2t	A2s	1350

Terminal characteristics

Control terminals	Type	Screw
Terminals tool		Blade 3.5mm
Tightening torque control terminals	Nm	0.5Nm
	Ibin	4.5
Conductor section connectable (control terminals) with 1 or 2 wires min...max		
	AWG stranded	n° 28...12
	Flexible w/o lug	mm2 0.75...2.5
	Flexible c/w insulated spade lug	mm2 0.75...2.5
Load terminals	Type	Screw
Load terminals tool		PH2
Tightening torque load terminals	Nm	1.5
	Ibin	13.3
Conductor section connectable (load terminals) with 1 or 2 wires min...max		
	AWG stranded	n° 18...10

Flexible w/o lug	mm ²	1...6
Flexible c/w insulated spade lug	mm ²	1...16

Operating position	allowable	On vertical plane
Fixing		Screw or on 35mm DIN rail

Ambient conditions

Temperature	Operating temperature	min	°C	-40
		max	°C	+80
	Storage temperature	min	°C	-40
		max	°C	+130

Dimensions

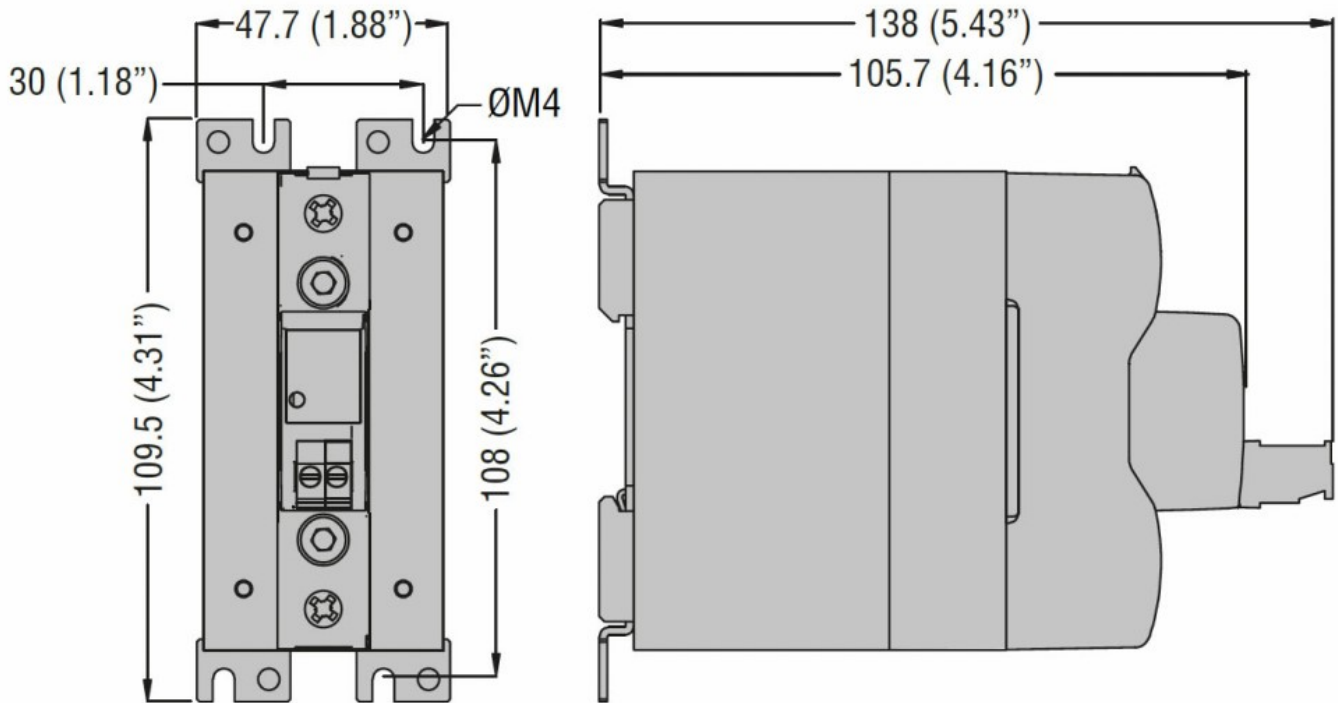

Wiring diagrams

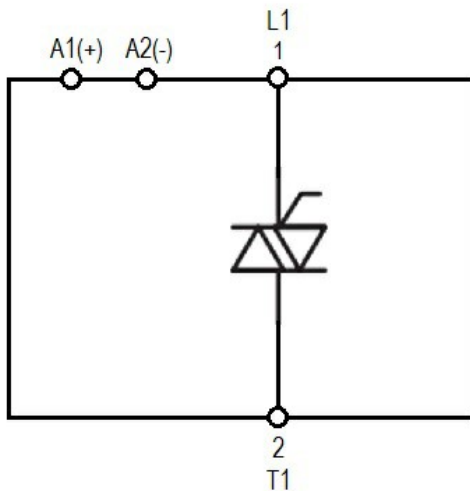

Certifications and compliance

Certifications

IEC/EN/BS 60335-1
IEC/EN/BS 60947-4-2
IEC/EN/BS 60947-4-3
IEC/EN/BS 62314

Compliance

cULus

ETIM classification

EC000066 - Power contactor, AC switching