



General characteristics

General characteristics

Housing Material	Polymer thermoplastic
Rod material	Long solid

Contact characteristics

Type of contact	1NO+1NC Slow action		
Thermal current I _{th}	A	10	
IEC/EN 60947-5-1 designation	A600 Q600		
Rated insulation voltage U _i	V	690	
Rated impulse withstand voltage U _{imp}	kV	6	
Insulation class	II		
Short-circuit protection with fuse	Class/A	10 gG/SC QUICK FUSE	

Switching speed

	min	m/s	0.5
	max	m/s	1.5
IEC Conventional free air thermal current I _{th} ≤ 40°C	A	10	
Resistance per pole (average value)	mΩ	<10	

Operations

Mechanical life	cycles	100000
B10d	cycles	100000
Mechanical operation	cycles/h	3600

Output characteristics

Mechanical life	cycles	100000
-----------------	--------	--------

Mechanical features

Operating head fixing	Locking bayonet insert
-----------------------	------------------------

Operating torque

	Ncm	15
	ozin	21.2

Tightening torque (Max)

Switch fixing	Nm	2.5
	lbin	22.1

Contact terminals	Nm	0.8
	lbin	7

Body lid screw fixing	Nm	0.8
	lbin	7

Conductor section

AWG/Kcmil	min	16
-----------	-----	----

		max	14
IEC		min	mm ² 1.5
		max	mm ² 2.5
Cable connection			Self-releasing screw terminal
Cable entry			M20 on the bottom
Ambient conditions			
Pollution degree			3
Temperature			
	Operating temperature	min	°C -25
		max	°C +70
	Storage temperature	min	°C -40
		max	°C +70

Dimensions

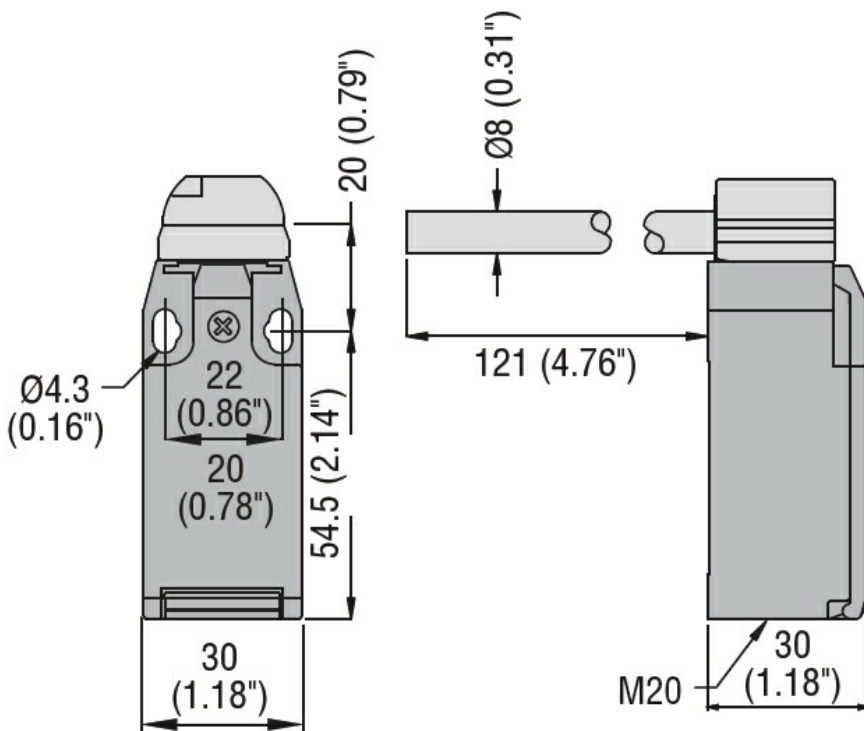

Wiring diagrams

Slow action



Certifications and compliance

Compliance

CSA C22.2 n° 14

EN 50047

IEC/EN 60204-1

IEC/EN 60947-1

IEC/EN 60947-5-1

UL508

Certificates

CCC

cULus

EAC

ETIM classification

ETIM 8.0

EC000030 - End switch