



General characteristics

Material

Housing

Polymer
thermoplastic

Contact characteristics

Type of contact

1NO/NC

Thermal current I_{th}

A

15

IEC/EN 60947-5-1 designation

A600 P300

Rated insulation voltage U_i

V

250

Switching speed

min

m/s

0.01

max

m/s

1

Operating speed

min

m/s

0.05

max

m/s

1

IEC Conventional free air thermal current I_{th} ≤ 40°C

A

15

Resistance per pole (average value)

mΩ

<15

Conductivity

10mA 5V

Mechanical features

Terminals type

Solder

Operating head fixing

Fixed

Operating torque

N

2.5

ozin

9

Weight

g

52

Operations

Mechanical life

cycles

20000000

Electrical life

cycles

500000

Mechanical operation

cycles/h

240

Ambient conditions

Temperature

Operating temperature

min

°C

-25

max

°C

+70

Storage temperature

min

°C

-40

max

°C

+70

Resistance & Protection

IP degree

Body housing

IP00 or IP20 with
terminal shroud

Pollution degree

3

Dimensions

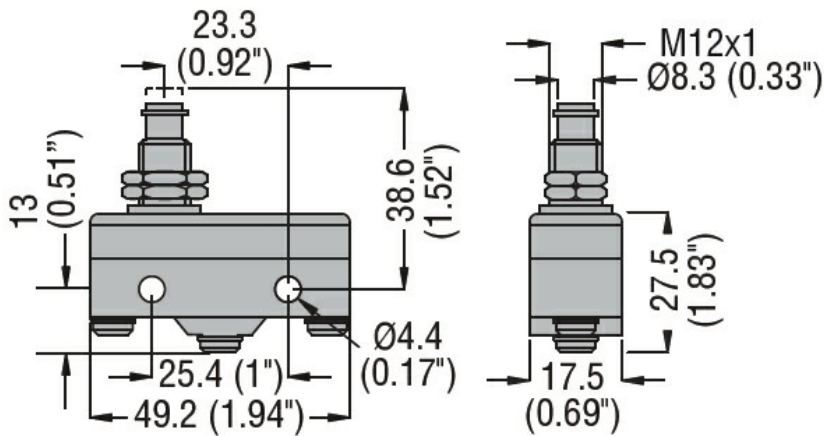

Wiring diagrams

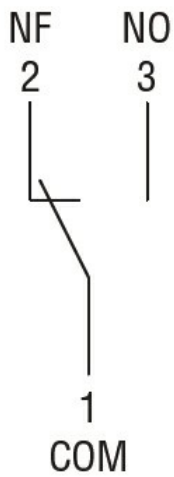

Certifications and compliance

Compliance

CSA C22.2 n° 14.

IEC/EN 60947-1

IEC/EN 60947-5-1

IEC/EN 61058-1

UL508

Certificates

cURus

EAC

ETIM classification

ETIM 8.0

EC000030 - End
switch