



General characteristics

Colour	Green
Type of positions	Monoblock pilot light
Material	Polyamide
IEC degree of protection	IP66, IP67 and IP69K on front; IP20 on rear

Electrical characteristics

Rated frequency	Hz	50-60
Supply voltage (AC)	V	48 (-15% ... +10% Ue)
Supply voltage (DC)	V	48 (-15% ... +10% Ue)

Operations

Electrical life	hours	>30000
-----------------	-------	--------

Mechanical features

Tightening torque for terminals max	Nm	0.8
Terminals screw	Screw termination	
Conductor section	AWG/kcmil conductor section	
	min	18
	max	16
	IEC	
	max	mm ² 2.5
Fixing	Ring fixing Ø22mm	
Weight	g	21

UL technical data

UL degree of protection	Type1, 2, 3R, 4, 4X, 12, 12K on front
-------------------------	---------------------------------------

Ambient conditions

Temperature	Operating temperature		
	min	°C	-25
	max	°C	+70

Dimensions

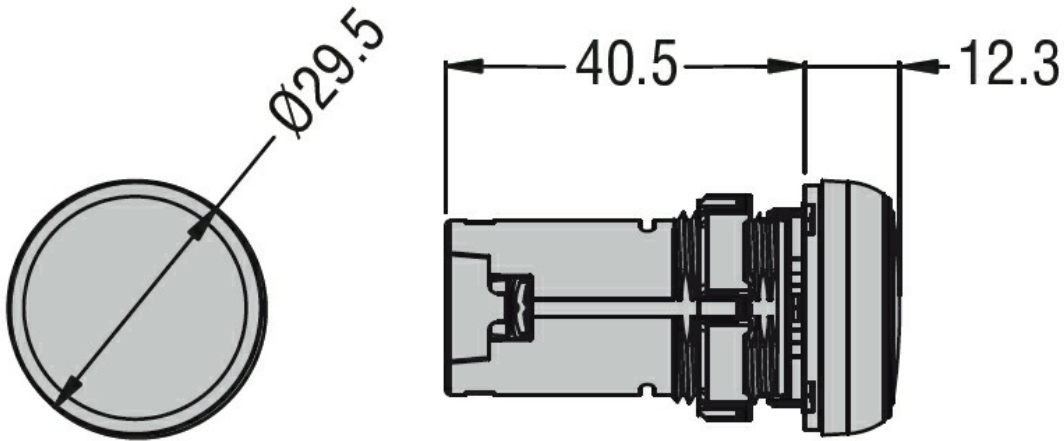

Wiring diagrams

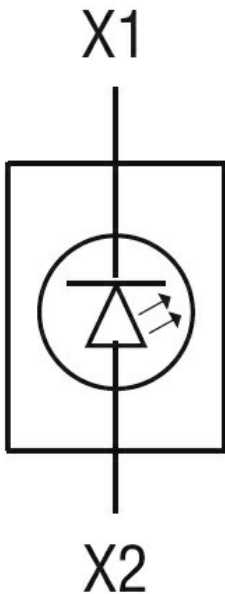

Certifications and compliance

Compliance

CSA C22.2 n° 14
IEC/EN/BS 60947-1
IEC/EN/BS 60947-5-1
UL508

Certificates

cULus
EAC

ETIM classification

ETIM 8.0

EC000272 -
Indicator light
complete