



General characteristics

Colour	Grey
IEC degree of protection	IP66 and IP67

Mechanical features

Weight	g	603
--------	---	-----

UL technical data

UL degree of protection	NEMA 4X
-------------------------	---------

Ambient conditions

Temperature

Operating temperature

min	°C	-25
max	°C	+70

Storage temperature

min	°C	-40
max	°C	+85

Dimensions

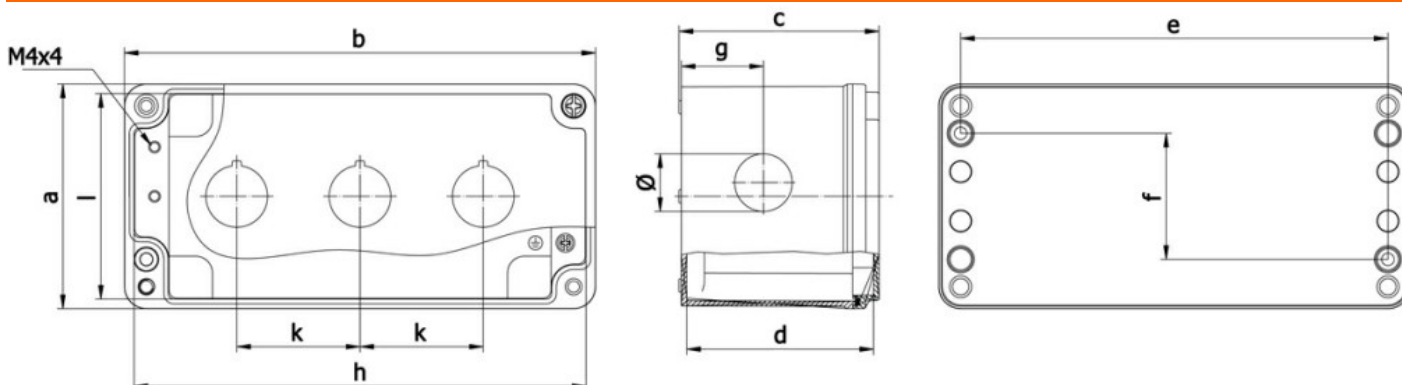

a	b	c	d	e	f	g	h	l	k	Ø
80	170	73	67	156	46	30	165	75	45	21

Certifications and compliance

Compliance

CSA C22.2 n° 14
IEC/EN 60947-1
IEC/EN 60947-5-1
UL508

Certificates

cULus
EAC

ETIM classification

ETIM 8.0

EC000200 -
Enclosure for
control circuit
devices