



General characteristics

Diameter	mm - inch	50 / 1.97
Material		Plastic

Mechanical features

Weight	g	76
--------	---	----

Ambient conditions

Temperature	Operating temperature	min	°C	-30
		max	°C	+50

Dimensions

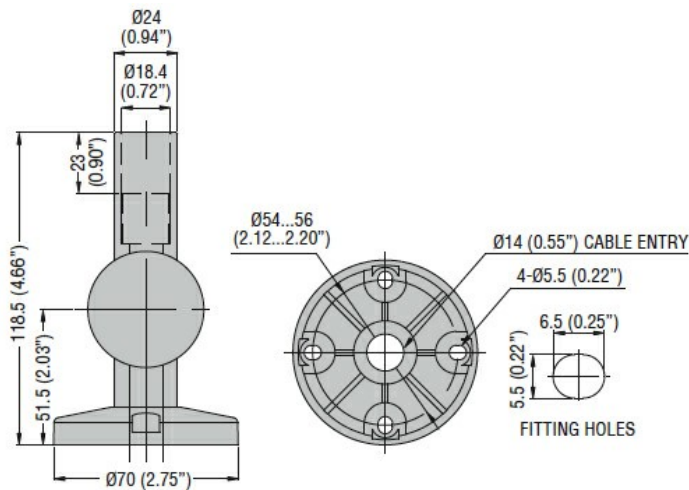

Certifications and compliance

Compliance	IEC/EN/BS 60947-1
	IEC/EN/BS 60947-5-1

ETIM classification

ETIM 8.0	EC001153 - Wall bracket for signal tower
----------	--