



**General characteristics**

Diameter	mm - inch	70 / 2.75
Material		Metal

**Mechanical features**

Weight	g	101
--------	---	-----

**Ambient conditions**

Temperature	Operating temperature	min	°C	-30
		max	°C	+50

**Dimensions**

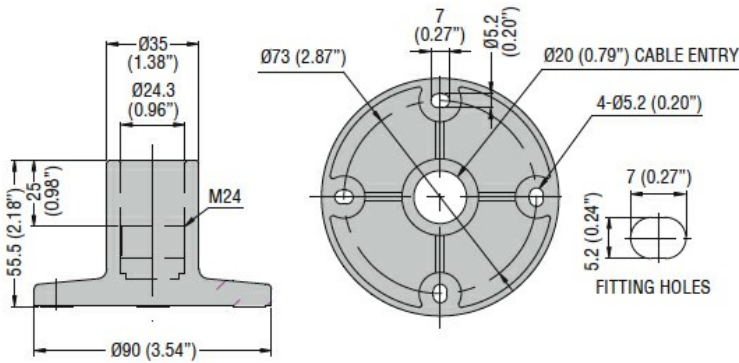

**Certifications and compliance**

Compliance	IEC/EN/BS 60947-1
	IEC/EN/BS 60947-5-1

**ETIM classification**

ETIM 8.0	EC001153 - Wall bracket for signal tower
----------	--