



General characteristics

Diameter	mm - inch	70 / 2.75
Supply voltage (DC)	V	12...24
IEC degree of protection		IP65
Power consumption	VA	1

Mechanical features

Terminals screw		Spring terminals
Conductor section		
	AWG/Kcmil	
	min	16
	max	24
	IEC	
	min	mm ² 0.25
	max	mm ² 1.5
Weight	g	170

Ambient conditions

Temperature			
	Operating temperature		
	min	°C	-30
	max	°C	+50

Dimensions

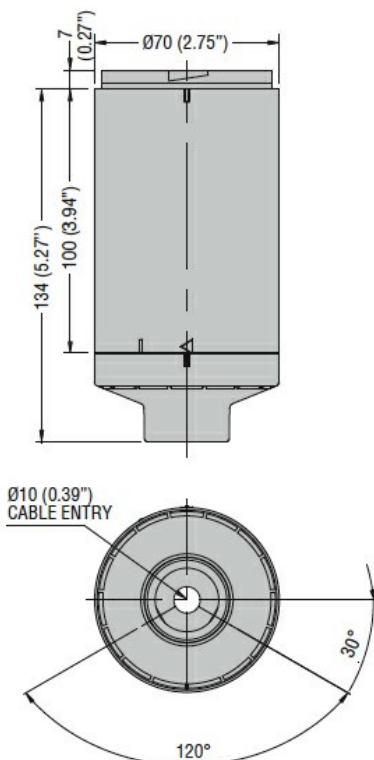

Wiring diagrams

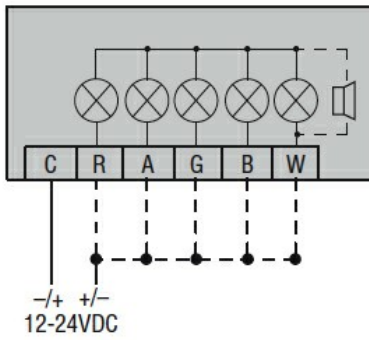

Certifications and compliance

Compliance

CSA C22.2 n° 14
 IEC/EN/BS 60947-1
 IEC/EN/BS 60947-5-1
 UL508

Certificates

cULus

ETIM classification

ETIM 8.0

EC001154 -
 Stand for signal
 tower without
 tube