



Counterweights

Counterweight	Internal
Activation angle	15°

Relay outputs

Number of relays	Nr.	1
Contact arrangement		1 changeover contact C/O-SPDT
Rated operational voltage AC (IEC)	VAC	250
Contact ratings		AC1 10A 250VAC AC15 4A 250VAC

Connections

Maximum cable length	m / ft	15
----------------------	--------	----

Ambient conditions

Temperature	Operating temperature	min	°C	0
		max	°C	+50
	Storage temperature	min	°C	-20
		max	°C	+80

Maximum operating pressure	bar	5
Maximum installation depth	m	50

Housing

Cable material	Neoprene H07 RN-F3X1	
Float casing material	Polypropylene	
IEC degree of protection	IP68	
Weight	g	2460

Dimensions

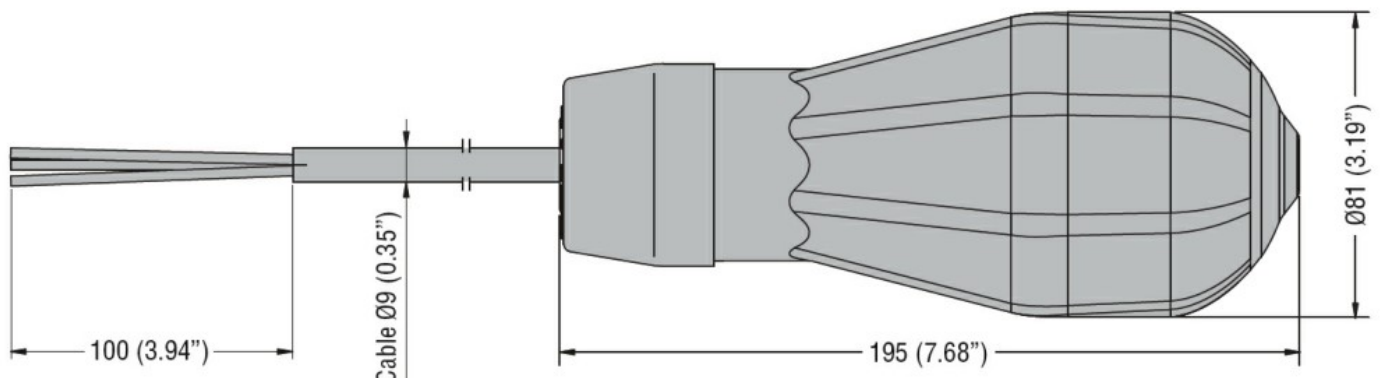

Certifications and compliance

Compliance

IEC/EN 60730-1
IEC/EN 60730-2-15

Certificates

TÜV-SUD

ETIM classification

ETIM 8.0

EC001447 - (Fill)
level monitoring
relay