

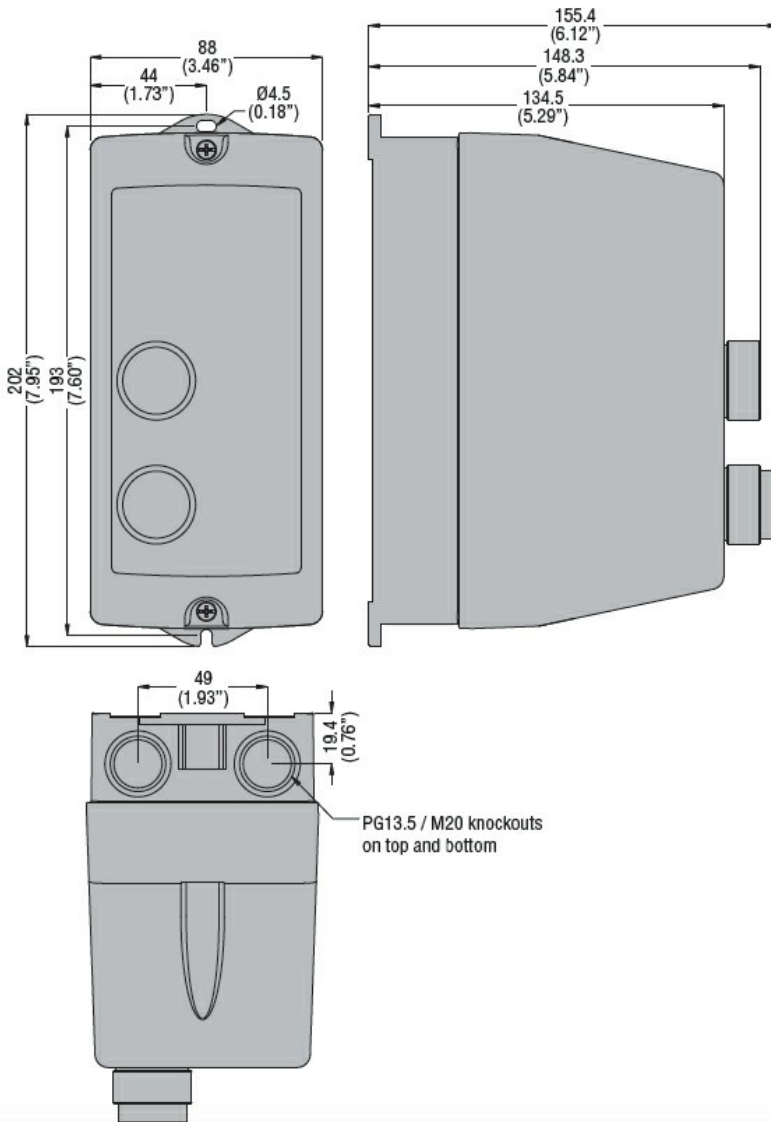

Electrical features			
Maximum operating current ($\leq 440V$)	A		18
Components			
Starter enclosure standard supplied			M1PA
Contactor standard supplied			BF1810A
Thermal relay to purchase separately			RF38...
UL technical data			
UL degree of protection			Type 1, 12K, 4, 4X
Mechanical features			
Weight	g		910
Ambient conditions			
Operating temperature	min	°C	-25
	max	°C	+60
Storage temperature	min	°C	-40
	max	°C	+70
Resistance & Protection			
IEC degree of protection			IP65
Dimensions			



Wiring diagrams



I = Start; O = Stop/Reset

Certifications and compliance

Compliance

IEC/EN 60947-1
IEC/EN 60947-4-1
UL508 CSA C22.2 n° 14

Certificates

CSAus
cULus
EAC

ETIM classification

ETIM 8.0

EC001037 -
Motor
starter/Motor
starter
combination