

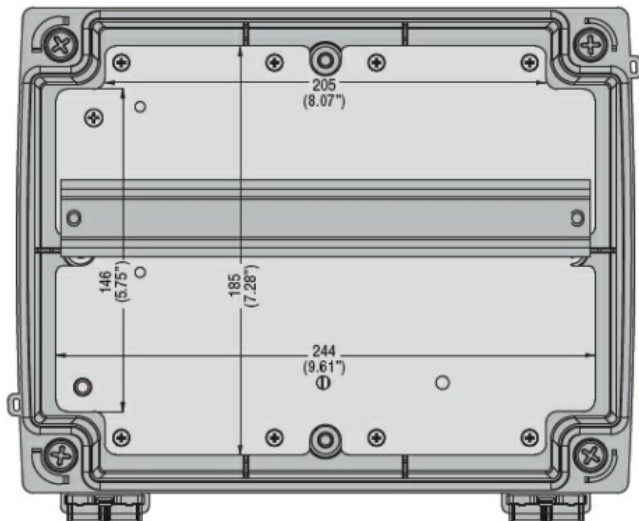

Electrical features			
Maximum operating current ($\leq 440V$)	A		50
Components			
Starter enclosure standard supplied			M3PA70
Contactor standard supplied			BF3200A, BF3200A, BF2510A
Thermal relay to purchase separately			RF38...
Auxiliary contact standard supplied			BFX1020, BFX1011, BFX1011
Contact characteristics			
IEC standard motor powers			
	230V	kW	15
	400V	kW	25
	440V	kW	25
	500V	kW	25
Mechanical features			
Weight		g	3800
Ambient conditions			
Operating temperature			
	min	°C	-25
	max	°C	+60
Storage temperature			
	min	°C	-40
	max	°C	+70
Resistance & Protection			
Frontal IP degree			IP65
Dimensions			

STAR-DELTA STARTER, ENCLOSED STARTER, WITH START AND STOP/RESET BUTTONS.
STARTING TIME UP TO 12 SECONDS AND A MAXIMUM OF 30 OPERATIONS/HOUR, MAX IEC
OPERATING CURRENT 50A. COIL VOLTAGE 230VAC 50/60HZ

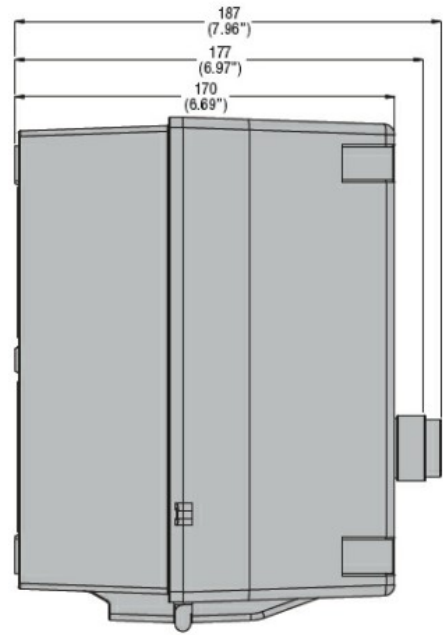
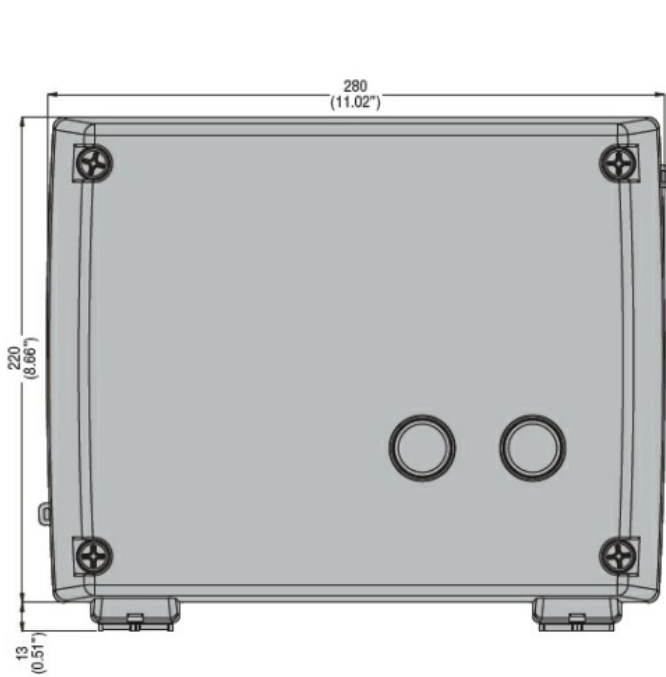

Drilling for surface fixing



Wiring diagrams

STAR-DELTA STARTER, ENCLOSED STARTER, WITH START AND STOP/RESET BUTTONS.
STARTING TIME UP TO 12 SECONDS AND A MAXIMUM OF 30 OPERATIONS/HOUR, MAX IEC
OPERATING CURRENT 50A. COIL VOLTAGE 230VAC 50/60HZ

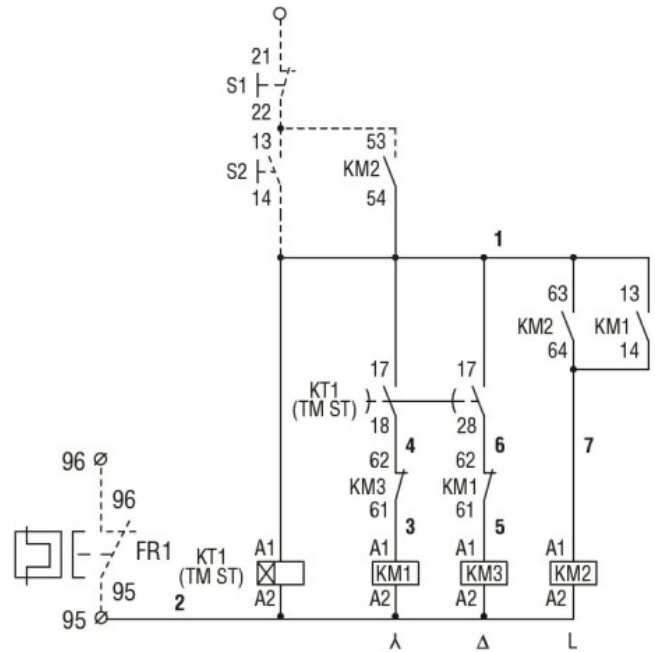
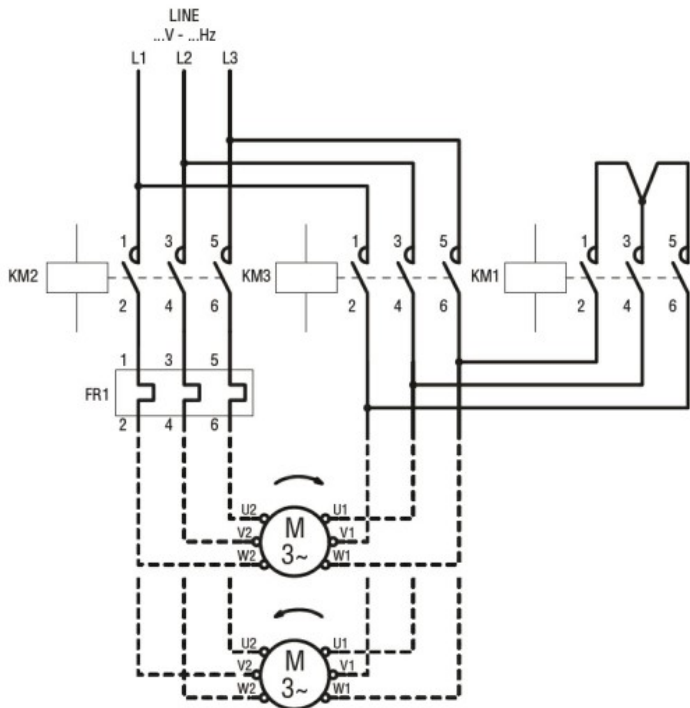

Certifications and compliance

Compliance

CSA C22.2 n° 14
for starters
IEC/EN 60947-1
IEC/EN 60947-4-1
UL508

Certificates

/

ETIM classification

ETIM 8.0

EC001037 -
Motor
starter/Motor
starter
combination