



General characteristics

Number of poles	Nr.	3
Overvoltage category		III
Pollution degree		3
Frontal IP degree		IP20
Type of release		Thermal
Protection fuse		
	gG (IEC)	A 315
	aM (IEC)	A 200
	K5 (UL)	A 500
Phase failure detection		no
Reset mode		Manual or automatic

Power circuit characteristics

Rated insulation voltage U_i IEC/EN	V	1000
Rated impulse withstand voltage U_{imp}	kV	6
Rated operational voltage	V	690
Operational frequency		
	min	Hz 50
	max	Hz 60
Operational current I_e		
	Operational current min	A 120
	Operational current max	A 200
Tripping class		10A
Test Button		Yes
Trip indicator		yes
Terminals		
	type	screw and flat washer
	screw	M8
	width	mm 20
	tool	Bar 13mm
Tightening torque for terminals		
	min	Nm 18
	max	Nm 18
	min	Ibin 13.3
	max	Ibin 13.3

Auxiliary circuit characteristics

Auxiliary contacts		
	NO	Nr. 1
	NC	Nr. 1
Auxiliary Rated insulation voltage U_i IEC/EN	V	690
Auxiliary Rated impulse withstand voltage U_{imp}	kV	6
Auxiliary Rated operational voltage	V	690
Operating current AC15		

	24V	A	3
	120V	A	3
	240V	A	1.5
	380V	A	0.95
	480V	A	0.75
	500V	A	0.72
	600V	A	0.6
<hr/>			
Operating current DC13			
	125V	A	0.11
	600V	A	0.22
<hr/>			
IEC Conventional free air thermal current I _{th} ≤ 40°C		A	10
<hr/>			
Terminals			
	Auxiliary circuit type		screw and washer
	Auxiliary circuit screw		M3,5
	Auxiliary circuit width	mm	8
	Auxiliary circuit tool		Phillips 2
<hr/>			
Conductor section			
	Auxiliary circuit Flexible w/o lug max	mm ²	2.5
	Auxiliary circuit Flexible c/w lug max	mm ²	2.5
<hr/>			
Tightening torque for terminals			
	Auxiliary circuit min	Nm	0.8
	Auxiliary circuit max	Nm	1
	Auxiliary circuit min	Ibin	0.59
	Auxiliary circuit max	Ibin	0.74
<hr/>			
UL/CSA and IEC/EN 60947-5-1 designation			B600-R300
<hr/>			
Ambient conditions			
Operating temperature			
	min	°C	-25
	max	°C	60
<hr/>			
Storage temperature			
	min	°C	-50
	max	°C	70
<hr/>			
Compensation temperature			
	min	°C	-20
	max	°C	60
<hr/>			
Max altitude		m	3000
<hr/>			
Mechanical features			
Operating position			
	normal allowable		Vertical plan ±30°
<hr/>			
Fixing			Screw
<hr/>			
Weight		g	2150
<hr/>			
UL technical data			
Full-load current (FLA) for three-phase AC motor			
	at 480V	A	200
	at 600V	A	200
<hr/>			
Dimensions			

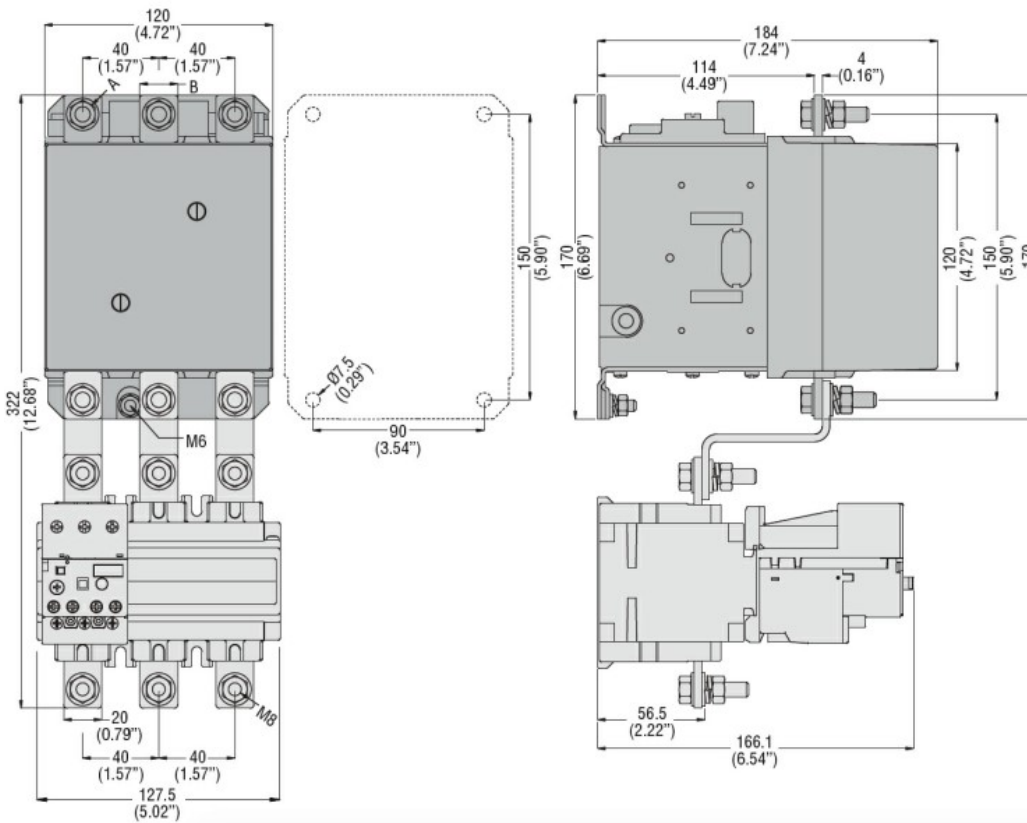

CONTACTOR TYPE	A	B
B115	M6	15 (0.59")
B145	M8	20 (0.79")
B180	M8	20 (0.79")

Wiring diagrams

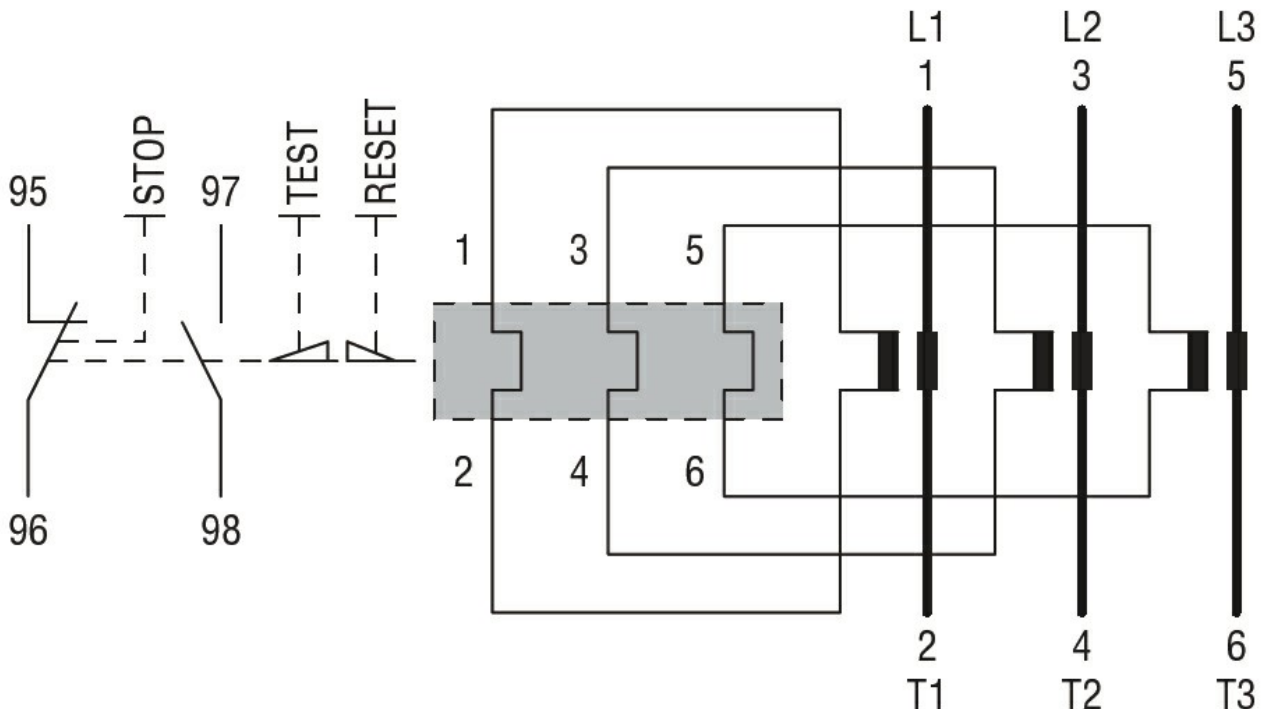

Certifications and compliance

Compliance

CSA C22.2 n° 14

IEC/EN 60947-1

IEC/EN 60947-4-1

UL508

Certifications

cULus
EAC

ETIM classification

ETIM 8.0

EC000106 -
Thermal overload
relay