



Mechanical features

Weight g 345

Operations

Mechanical life cycles 100000

Ambient conditions

Temperature			
Operating temperature			
	min	°C	-25
	max	°C	+60
Storage temperature			
	min	°C	-50
	max	°C	+80

IEC degree of protection IP65

UL degree of protection 4X

Dimensions

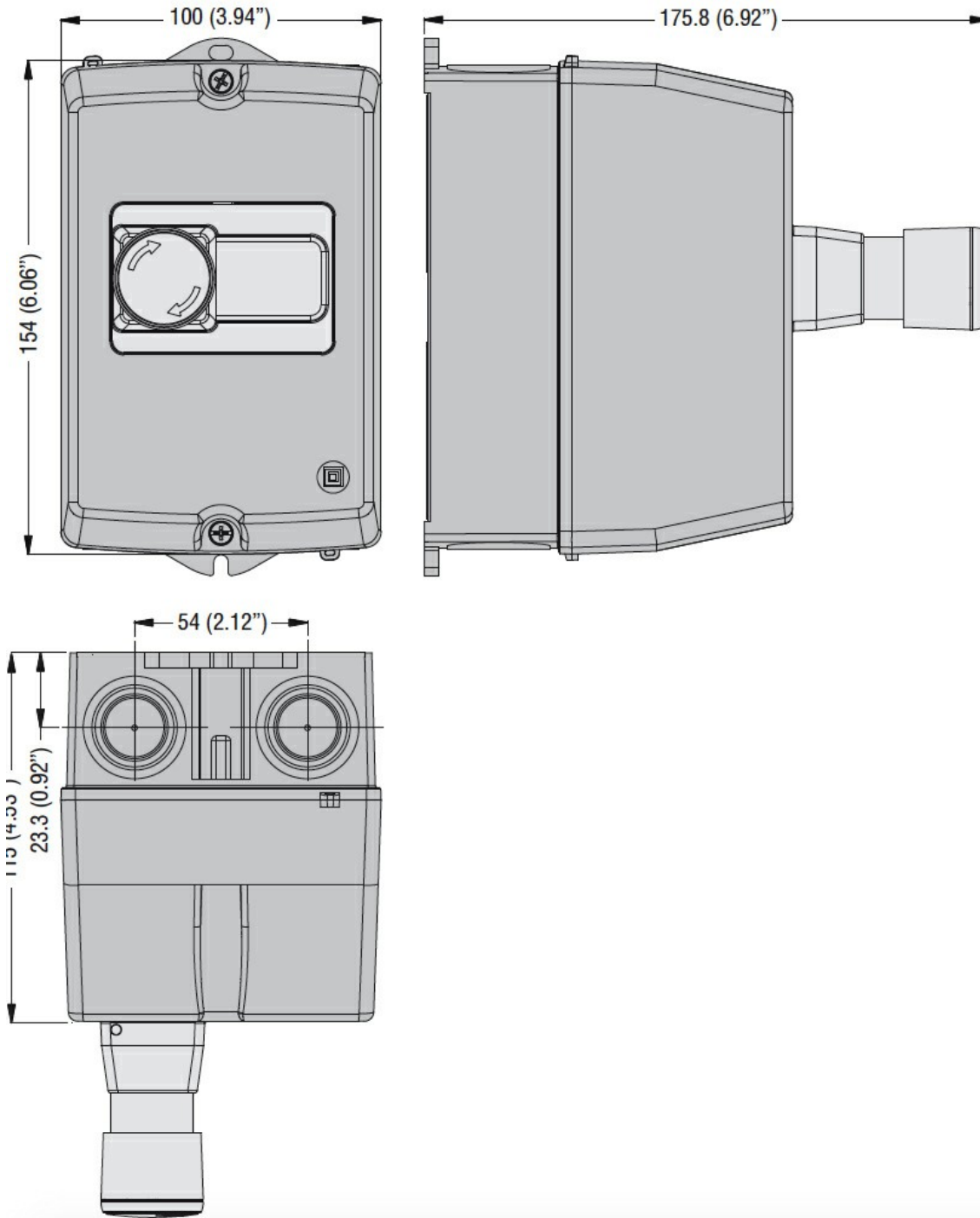

Certifications and compliance

Compliance

CSA C22.2 n° 14

IEC/EN 60947-1

IEC/EN 60947-5-1

UL508

Certificates

cULus

EAC

ETIM classification