



General characteristics

Rated current (Ie)	A	150
Inductance	mH	0.08
Rated power	VA	1700
Rated output current	A	150
Rated output power	kW	55...75

Technical features

Rated mains voltage	VAC	400
Operating mains voltage range	VAC	170...530
Rated mains frequency	Hz	50/60
Saturation current		1.5*Ie
Power loss		120W
THD		40%

Ambient conditions

Temperature	Operating temperature		
	max	°C	+40
Max altitude		m	1000
Insulation class			Class F
Working class			Class F

Housing

Material		Alluminium
Installation position		Vertical
IP degree of protection		IP00
Dimensions (W x H x D)	mm	240x160x205
Weight	Kg	18

Dimensions

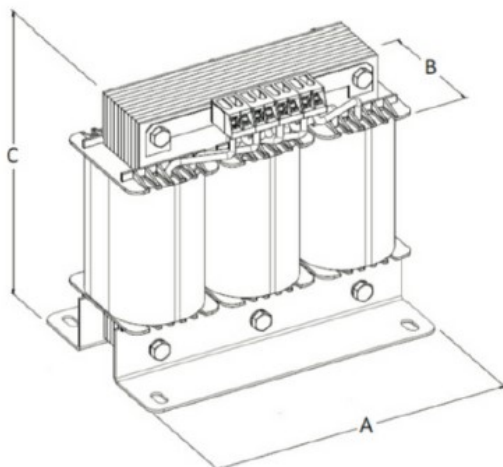

	VLXM012	VLXM025	VLXM050	VLXM100	VLXM150	VLXM300
A	150	180	180	250	240	300
B	75	90	100	150	160	140
C	150	160	200	205	205	260

Wiring diagrams

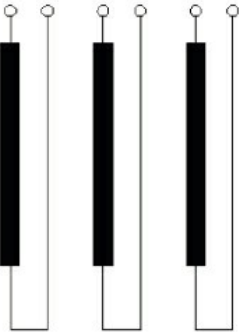

Certifications and compliance

Compliance

IEC/EN/BS 61558-1

ETIM classification

ETIM 8.0

EC002025