

# L-09 / L-09 WALL

1018A1.99

**novalux**  
ITALIAN LIGHTING DESIGN SINCE 1948

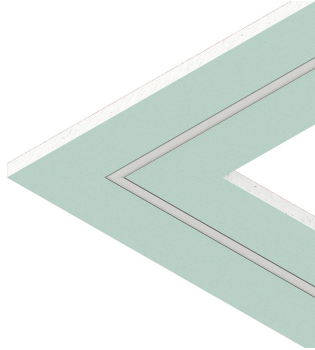

## Features

Use: Indoor  
Type of installation: RECESSED INTO PLASTERBOARD  
Emission: DIRECT  
L: 998x998mm  
A: 115mm  
H: 12.5mm  
Made in: ITALY  
Warranty: 5 years  
Weight: 3.94kg

## Tech data

IP: 40

[L-09 / L-09 WALL: View more product info](#)

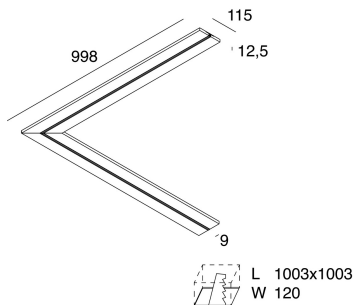

Novalux S.r.l. via Marzabotto, 2 40050 Funo di Argelato (BO) Italy  
Tel: +39 051 860558 · Fax +39 051 6647859 · Mail: info@novalux.it · VAT number 00536541204 · novalux.com  
Company subject to the management and coordination by SLV GmbH

This technical data sheet is owned by Novalux S.r.l., all rights reserved. Novalux S.r.l. reserves the right to make changes without prior notice.  
Last update: 6/8/2025, 12:53:27

# L-09 / L-09 WALL

1018A1.99

**novalux**  
ITALIAN LIGHTING DESIGN SINCE 1948

## SCREENS

---

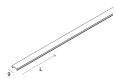

L-09: DIFF. OPALE L=6000

**1018A2.99**



Novalux S.r.l. via Marzabotto, 2 40050 Funo di Argelato (BO) Italy  
Tel: +39 051 860558 · Fax +39 051 6647859 · Mail: [info@novalux.it](mailto:info@novalux.it) · VAT number 00536541204 · [novalux.com](http://novalux.com)  
Company subject to the management and coordination by SLV GmbH

This technical data sheet is owned by Novalux S.r.l., all rights reserved. Novalux S.r.l. reserves the right to make changes without prior notice.  
Last update: 6/8/2025, 12:53:27