

# HERO B

108740.20 + 108904.99

HERO B: 79W 2.7K 1960 DALI CAF + HERO: DIFF. OPALE PER 1960

**novalux**  
ITALIAN LIGHTING DESIGN SINCE 1948

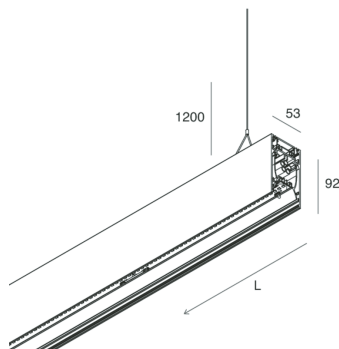
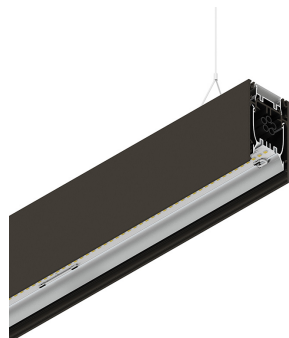

## Features

Use: Indoor  
Type of installation: SUSPENDED  
Emission: DIRECT/INDIRECT  
Optics: OPAL  
Colour: CAFFE  
Dimming: DALI  
Emergency: NO  
L: 1960mm  
A: 53mm  
H: 92mm  
Made in: ITALY  
Warranty: 5 years  
Weight: 7kg

## Tech data

Luminaire input power: 88.8W  
Luminaire luminous flux: 7491lm  
Indirect luminous flux: 4151lm  
IP: 40  
Insulation class: I  
No. of driver per product: 3  
Supply voltage: 220-240V 50/60Hz  
SELV: Si

## Source

Light source: LED  
Source power: 79W  
Colour temperature: 2700K  
CRI: >90  
Colour tolerance: 3 Step MacAdam  
LED lifespan: 50000h L90 B10

## Compliance

CEI EN 60598-1:2021 + A11:2023, CEI EN 60598-2-1:2022

## Standards

Photobiological risk: RISK GROUP 0 Certified fixture in EXEMPT GROUP, in accordance with CEI EN 62471:2010-01, IEC TR 62778:2014.

CAM edilizia: The product complies with the requirements for public buildings, ministerial decree of 23rd June 2022 n.256.

[HERO B: View more product info](#)



Novalux S.r.l. via Marzabotto, 2 40050 Funo di Argelato (BO) Italy  
Tel: +39 051 860558 · Fax +39 051 6647859 · Mail: info@novalux.it · VAT number 00536541204 · novalux.com  
Company subject to the management and coordination by SLV GmbH

This technical data sheet is owned by Novalux S.r.l., all rights reserved. Novalux S.r.l. reserves the right to make changes without prior notice.  
Last update: 6/8/2025, 13:35:22

# HERO B

108740.20 + 108904.99

HERO B: 79W 2.7K 1960 DALI CAF + HERO: DIFF. OPALE PER 1960

**novalux**  
ITALIAN LIGHTING DESIGN SINCE 1948



## Features

Use: Indoor  
Optics: OPAL  
L: 1960mm  
A: 48mm  
H: 6mm  
Made in: ITALY  
Warranty: 5 years  
Weight: 0.4kg

## Tech data

IP: 40



Novalux S.r.l. via Marzabotto, 2 40050 Funo di Argelato (BO) Italy  
Tel: +39 051 860558 · Fax +39 051 6647859 · Mail: info@novalux.it · VAT number 00536541204 · novalux.com  
Company subject to the management and coordination by SLV GmbH

This technical data sheet is owned by Novalux S.r.l., all rights reserved. Novalux S.r.l. reserves the right to make changes without prior notice.  
Last update: 6/8/2025, 13:35:22







# HERO B

108740.20 + 108904.99

HERO B: 79W 2.7K 1960 DALI CAF + HERO: DIFF. OPALE PER 1960

**novalux**  
ITALIAN LIGHTING DESIGN SINCE 1948

## COMPLETION ACCESSORIES

	HERO B: COPPIA TESTATE CAF	1087B1.20
	HERO B: MOD.CIECO 1680 CAF	1087A8.20
	HERO B: MOD.CIECO 1400 CAF	1087A7.20
	HERO B: MOD.CIECO ANG.DX 150 CAF	1087A5.20
	HERO B: MOD.CIECO 250 CAF	1087A3.20
	HERO B: MOD.CIECO ANG.SX 150 CAF	1087A4.20
	HERO B: MOD.CIECO 1120 CAF	1087A6.20

## MOUNTING ACCESSORIES

	HERO B: KIT COPPIA CAVI SOSP. 5 M	1087B2.99
	KIT ALIMENTAZIONE L1200 5P BIA	108921.01
	KIT ALIMENTAZIONE L3000 5P BIA	108922.01



Novalux S.r.l. via Marzabotto, 2 40050 Funo di Argelato (BO) Italy  
Tel: +39 051 860558 · Fax +39 051 6647859 · Mail: info@novalux.it · VAT number 00536541204 · novalux.com  
Company subject to the management and coordination by SLV GmbH

This technical data sheet is owned by Novalux S.r.l., all rights reserved. Novalux S.r.l. reserves the right to make changes without prior notice.  
Last update: 6/8/2025, 13:35:22

# HERO B

108740.20 + 108904.99

HERO B: 79W 2.7K 1960 DALI CAF + HERO: DIFF. OPALE PER 1960

**novalux**  
ITALIAN LIGHTING DESIGN SINCE 1948



KIT ALIMENTAZIONE L3000 5P CAF

**108922.20**



KIT ALIMENTAZIONE L1200 5P CAF

**108921.20**



Novalux S.r.l. via Marzabotto, 2 40050 Funo di Argelato (BO) Italy  
Tel: +39 051 860558 · Fax +39 051 6647859 · Mail: info@novalux.it · VAT number 00536541204 · novalux.com  
Company subject to the management and coordination by SLV GmbH

This technical data sheet is owned by Novalux S.r.l., all rights reserved. Novalux S.r.l. reserves the right to make changes without prior notice.  
Last update: 6/8/2025, 13:35:22